



CONSPEC®

ISCPM Quick Reference

Intrinsically Safe OPTIO Multi Gas Monitor Series

(Version 1.01)



Warranty and Disclaimer

A gas monitoring system alone cannot prevent hazardous conditions from occurring. The reliability of a gas monitoring system, and the resultant safety level is dependent on, and the responsibility of the user. The user's responsibilities include, but are not limited to:

- Ensuring that the correct equipment is specified for conditions at the particular site
- Following recommended installation guidelines
- Following recommended wiring guidelines
- Meeting applicable safety and electrical codes
- Scheduling regular calibrations and servicing
- Replacing inoperative or questionable parts or units

WARRANTY

Conspec Controls Inc. provides warranty service for one (1) year from the shipping date on all electronic and mechanical components. Sensor elements are covered under warranty for a period of six (6) months. Warranty service is limited to defects in materials and workmanship on units which fail under normal use. Conspec will repair or replace any unit found to have failed due to defects in materials or workmanship. This warranty is voided if the unit has been misused, damaged due to incorrect wiring, or altered before return to the factory. No other warranty is authorized other than the above.

Before returning a product for service, call Conspec Controls Inc. for a Return Authorization Number (RA#) at (800) 487-8450. Returned units should be packaged securely as damages incurred during shipping are not covered under warranty.

Wiring/Installation

Locate a suitable location free of drips and drafts that allows the user to safely access the unit. The I.S. Multi Gas Monitor shall be mounted so the detection head is pointing downward. Securely mount the unit using industry approved methods and materials taking into account sound mechanical and electrical practices.

It is the user's responsibility to follow all applicable Federal, State, Local Building and Electrical Codes including NEC Guide Lines.

A hardwired I.S. Multi Gas Monitor is powered via a **5-conductor 18-22AWG shielded cable.**

Power to the I.S. Multi Gas Monitor should be isolated from process power. The use of an isolated power supply (Clean Power) is strongly recommended when the Industrial Gas Monitor is part of a personnel safety system. In most cases, building and electrical codes require the use of a conduit to protect electrical wiring and prevent tampering. Conspec recommends electrical wiring to the Industrial Gas Monitor is placed in a conduit.

Installation Recommendations

1. Isolate process power from safety equipment power with proper grounding techniques
2. Install ALL equipment to meet I.S Standards.
3. Ground all cable shields
4. Isolate DC common from earth ground
5. Bond earth grounds to prevent ground loops

Hardwired (Terminal Block) Input Wiring

For hardwired (terminal block input wiring) monitors, use the following wiring diagram.

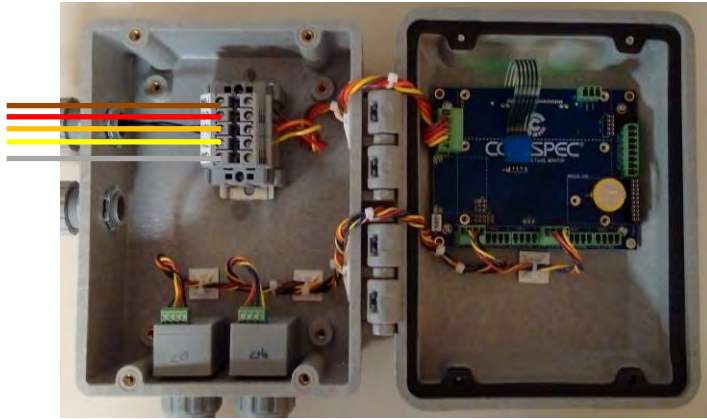

Wire Colour	RS485 Function	Trunk/RS232 Function
Brown	B/-	TX (Data Out)
Red	V+	V+
Orange	GND	GND
Yellow	A/+	RX (Data In)
Grey	SHIELD	SHIELD

Relay Ratings

Maximum Switching Power	60 W, 125 VA
Maximum Switching Voltage	220 VDC, 250 VAC
Maximum Switching Current	2 A
Maximum Carrying Current	2 A

I/O Wiring (MGM6-FC Only)

Wiring to the terminal blocks should be performed by a qualified technician.

1. Pass the wires through the black cable glands on the sides of the enclosure.
2. Strip and insert the end of the wires into the terminal blocks.
3. Secure the wires in place by tightening the screws with a slotted screwdriver.

Digital Input Terminals

The digital inputs are used to wire straight forward switches into the I/O Controller (5VDC MAX).

Analog Input Terminals

The analog input terminals are used for 5V MAX or 4-20mA analog inputs into the I/O Controller. If used as 4-20mA input, connect a 220Ω (5W) resistor between input and ground.

Relay Output Terminals

Relays can be configured as Standard (Normally DE-ENERGIZED) or as Fail Safe (Normally ENERGIZED). Relays can be associated with any alarm from any sensor or alarm combination from different sensors, see page 6 for relay configuration details.

Analog Output Terminals

The two 4-20mA output terminals can be associated with an installed sensor; see page 6 for details. A 4-20mA output card must be installed for this option to be available to the user.

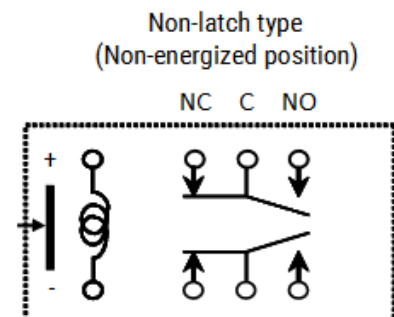

MAIN SCREEN

Once the warm up timer clears, the display will show the “Main Screen”:

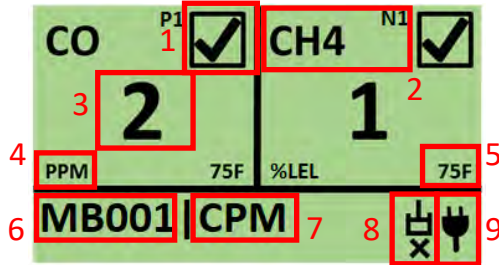

1. **Status:** Gas sensor status. See table below for different statuses.

	Normal gas reading and no alarms breached.
	Sensor Fail High (Above MAX range)
	Sensor Fail Low (Below MIN range). *May occur when sensor ages.
	Sensor reading is in alarm 1
	Sensor reading is in alarm 2
	Sensor reading is in alarm 3
	Sensor reading is in alarm 4
	Calibration is due, calibration period is user defined
	Sensor is in warm up delay
	Dislodged sensor. The sensor element is mechanically dislodged from the board or is missing.

- 2. **Sensor Type:** Sensor type and port number
- 3. **Reading:** Live reading.
- 4. **Units:** Gas unit of measurement (e.g. PPM)

- 5. **Temperature:** Sensor temperature reading. The user can switch between °C/°F.
- 6. **Address:** MODBUS address of the monitor.
- 7. **Name:** Device name (default: CPM)
- 8. **Communications Status:** Connected serial, connecting to wireless network, connected wireless or disconnected.
- 9. **Power :**Power source: Wired or Battery

When the user presses any of the on-board push buttons, the menu pops up onscreen:

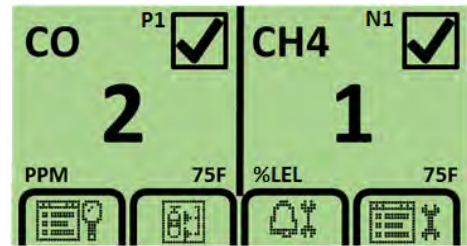

	Review Screens: provides additional information screens such as: sensor info, calibration info, I/O status, Modbus statistics, etc. Scroll Left/Right
	Calibration: shortcut button to calibrate sensors.
	Alarm Setup: shortcut button to configure alarm levels
	Menu access: Menu access button to configure monitor settings. (USER or ADMIN access based on password)

The default USER password is: 123



IR Remote Menu Shortcuts

The menus can also be accessed using the shortcut buttons on the IR remote while on the main screen.

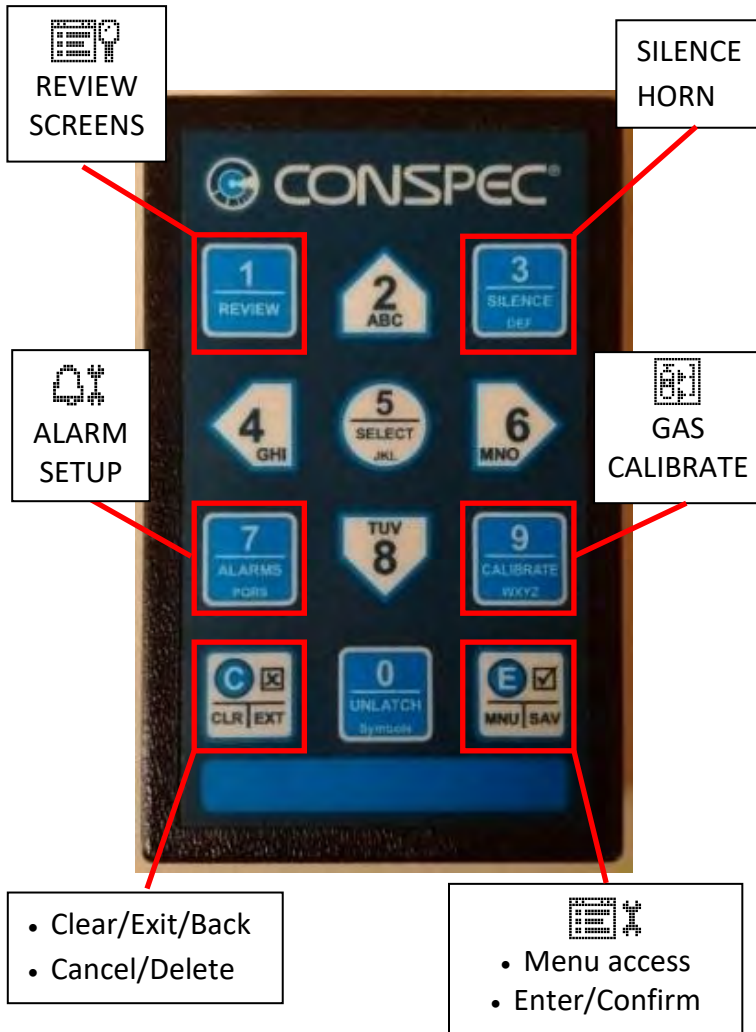

CALIBRATION

Select target sensor if multiple sensors are installed

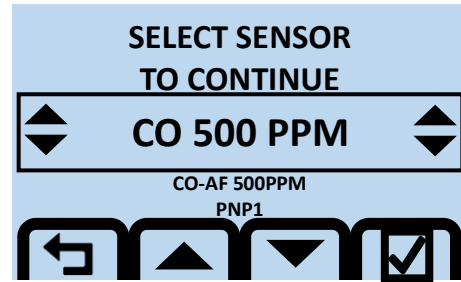

ZERO GAS CALIBRATION

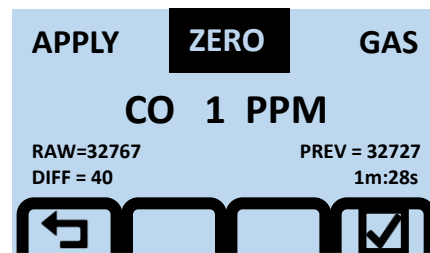

- **RAW:** The current ADC reading.
- **PREV:** The previous calibration ADC.
- **DIFF:** The difference between the previous and the current ADC values.

Apply zero air (20.9% oxygen balanced in N₂) until the RAW ADC stabilizes. Minimum time of 2-3min is recommended. Most EC sensors have a zero ADC reading of 32767. **For oxygen sensors, use Nitrogen (N₂) as the Zero Gas.**

SPAN GAS CALIBRATION

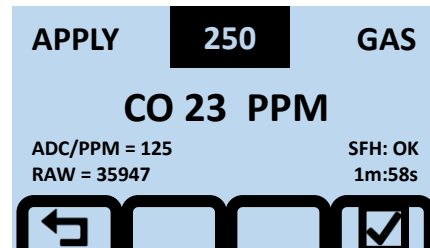

Apply the target gas value shown on screen until RAW ADC stabilizes. A minimum time of 2-3min is recommended. **For oxygen sensors, use zero air (20.9% oxygen balanced in N₂) for Span instead.**

Rules for a successful calibration

NDIR sensors (CH4 and CO2):

1. For CH4 sensors, Zero must be less than 0.5%VOL or 10%LEL
2. Span reading must be $\pm 50\%$ of the Span value.
Example: if the span value is 50%LEL, the span reading must fall between 25%LEL and 75%LEL to pass.
3. For NDIR ONLY, zero calibration can be completed independently from Span by exiting the span mode. This is Manual Zero.

PNP sensors (CO, O2, H2S, H2, NO, NO2, and NH3):

1. Minimum SPAN resolution (ADC/PPM) must be greater than 10 ADC/PPM.
2. The current SPAN resolution must be within $\pm 50\%$ of the previous SPAN resolution.
3. Sensor Fail High (SFH) must be < 65535 .
4. ZERO ADC must not equal SPAN ADC.







Purge Screen

1. If the reading is greater than AL1 when the calibration is completed, the display is automatically taken into the purge screen.
2. The reading must be below the AL1 value before exiting the purge screen.
3. The monitor remains in calibration mode until the user EXITS the purge screen.
4. If the user exits the purge screen while reading is above AL1, the monitor will alarm.

ALARMS SETUP

It is the user's responsibility to make sure the correct alarm levels are specified.

1. If more than one sensor is installed, select target sensor to configure its alarms.
2. Select the target alarm to configure









					
Sensor Fail High	Sensor Fail Low	Alarm 1	Alarm 2	Alarm 3	Alarm 4

Alarm options are:

- a. **Alarm Level:** Sensor reading that will trigger the alarm. The current set value is displayed at the top of the screen (now = X).
- b. **Hysteresis Level (ADMIN only):** When the sensor is in alarm, the reading must fall below the alarm level + hysteresis level to clear the alarm.
- c. **Alarm Hold Delay (ADMIN only):** The delay time that needs to elapse before alarm status is asserted. For example, if the delay hold time is 3 seconds, then if the value goes into an alarm state, it needs to stay in that state for a minimum of 3 seconds before the state is changed from normal to alarm. This is used to prevent nuisance alarms.
- d. **Alarm Enable/Disable:** The option to enable or disable an alarm. For example, if only the first 2 alarms are needed, then it is recommended to disable alarm 3 and alarm 4.
- e. **Alarm Direction:** Certain gases are dangerous as the values increase, such as CO. In a situation like that, select the rising condition. For other gases such as O2, it is dangerous to have falling levels. In that situation, use a falling condition.

MENU SETTINGS

The USER password menu access is limited to Span Setup, Gas Calibration, Alarm Setup, Serial Setup and MFP setup. All menu options are available for ADMIN password.

 Device Setup	 Sensor Setup	 Span Setup	 Gas Calibrate	 Alarm Setup
 Serial Setup	 Relay Setup	 MFP: DIO/AIN	 4-20mA Setup	

1. DEVICE SETUP (ADMIN only):

- Set Device Name:** Allows the user to assign a specific name to the monitor.
- Set Alarm SIL Time:** Specifies how long an alarm associated with a relay is silenced (only when alarm is asserted). This is mostly used for audible alarms (horn).
- Set Temperature Unit:** Set to °C or ° F.
- Set Backlight Brightness:** LCD backlight brightness.
- Set User Password:** Change user password.
- Set Admin Password:** Change admin password.
- Set Date/Time:** Setting time and date is important for data logger time-stamps and tracking calibration due events.

2. SENSOR SETUP (ADMIN only):

- Sensor Name Tag:** Allows the user to select a specific name for the sensor.
- Span Gas Value:** Calibration Span gas used. Recommended 50% of full range.
- Cal Period:** How often the gas monitor must be calibrated (e.g. 90 days). A CALDUE warning is displayed when specified number of days has passed since last calibration.

d. **Test Sensor Value:** Allows the user to test the alarms by asserting a test sensor value.

WARNING: The Monitor will output the test value as actual sensor reading and can trigger alarm(s) for the duration of the test.

- SPAN SETUP:** A shortcut to “Span Gas Value”.
- GAS CALIBRATE:** See page 4 for details.
- ALARM SETUP:** See page 5 for details.
- SERIAL SETUP:**
 - Address:** MODBUS address (1-247)
 - Serial Input:** RS485, RS232, Conspec Trunk
 - Baud Rate:** 4800, 9600, 19200, or 38400
 - Stop Bits:** ONE or TWO
 - Parity Bit:** EVEN/ODD/NONE
- RELAY SETUP:** This menu works by selecting items in the drop down for each option.
 - Relay:** Select (RELAY1 to RELAY6) to setup
 - Control:** Selects which ALARM# will control this relay. Select MODBUS if the relay is controlled via register map (Reg#336).
 - Drive:** STANDARD (Normally De-energized) or FAIL SAFE (Normally Energized).
 - Silence:** Allows remote IR button [3] to silence this relay in the event of an alarm. Enable it if a Horn is attached to the relay.
 - Relay Off:** Specify if a different alarm turns off the relay (default: Same Alarm). This is used in Fan control applications.
 - Sensor:** Select which sensor(s) the relay will be associated with. For example, if relay needs to trigger at Alarm 1 from ANY of the sensors attached then select: ALL (OR).
- MFP: DIO/AIN:** Set MFP ports to Analog Input, Digital Input, Digital Output or Sensor Input.
- 4-20mA SETUP (ADMIN only):**
 - 4-20mA Calibrate:** Calibrate 4mA or 20mA outputs. Use a multimeter to verify output.
 - 4-20mA In Source:** Associate the output of the 4-20mA port with an attached sensor.

MAINTENANCE

This Gas Detection Monitor requires evaluation every thirty (30) days to ensure accuracy by performing a bump test. Replace any inoperative or questionable parts immediately. This gas detection monitor requires calibration every ninety (90) days to ensure accuracy and to correct sensor drift. Conspec recommends that no modifications be made to this monitor without first consulting Conspec Technical Services. Modifying this equipment will void any warranty authorized by Conspec Controls Inc.

REPAIR

Any monitor found to be defective or questionable should be returned to Conspec Controls for evaluation and repair. Conspec requires any returned equipment to first be issued a Return Authorization Number (R.A.#) by calling Conspec at (800) 487-8450 Mon.-Fri. 8AM-5PM EST. Conspec also offers on-site Repair and Start-up service for Conspec Gas Detection Equipment.

REPLACEMENT PARTS

Spare parts can be stored under conditions that fall within the limits of the operation specifications. Please note, time frames for storing replacement sensor cells should be followed based on the manufacturer specifications.

CONTACT INFORMATION

Tech Support: (800) 487-8450
Mon-Fri 8AM-5PM EST
Conspec Sales: (800) 487-8450
Mon-Fri 8AM-5PM EST
Fax: (724) 489-9772

Sales e-mail

U.S.....sales.usa@conspec-controls.com

Cdn& Intl.....sales@conspec.ca

Technical support e-mail

U.S.....support.usa@conspec-controls.com

Cdn& Intl.....support@conspec.ca

Web site.....www.conspec-controls.com